

네르센 패브릭 소파 3인 1102

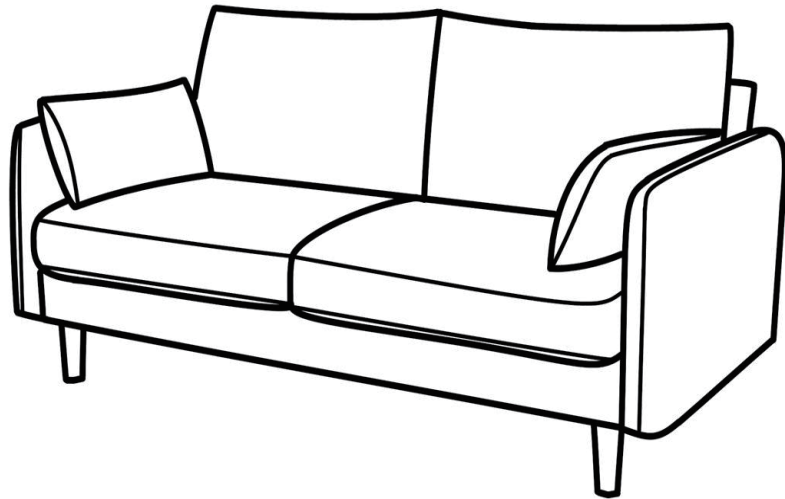

[취급주의]

- 가구사용시 임의적으로 휘발성있는 물질을 흘렸을 경우 가구표면의 손상이 발생하오니 주의하세요.
- 무리한 힘이나 충격을 가하지 마시고 수평을 유지하여 사용하세요.
- 직사광선이나 강한열 혹은 촉한을 피하여 주세요.
- 이동시 끌지마시고 들어서 이동하여 주세요.
- 테이프나 접착용품은 제품에 훼손을 일으킬수 있으니 주의하세요.
- 교환/취소/반품/환불 관련사항은 사이트 참조바랍니다.

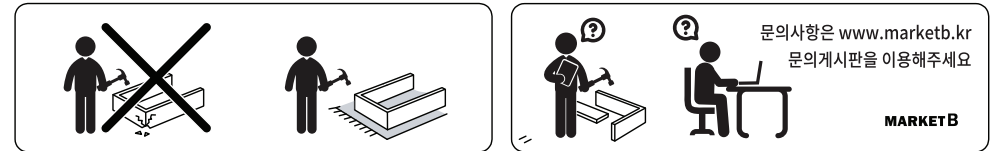

TIP

조립전 부품의 이상유무를 반드시 확인해주세요.



Ax2



Bx1

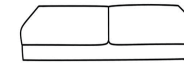

Cx1



Dx2



Ex2



Fx4



Gx6
8x20mm



Hx6
8x35mm



Ix1



Jx4

1

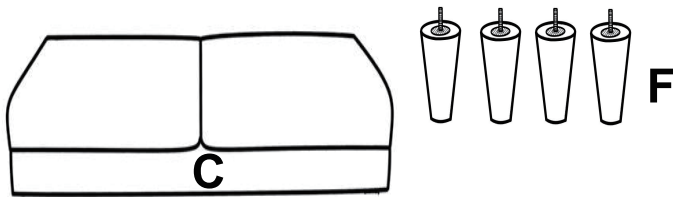
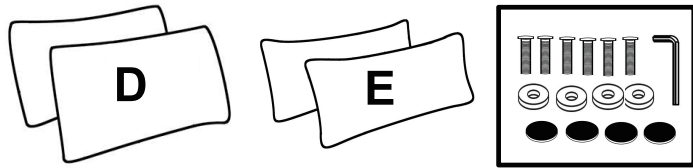
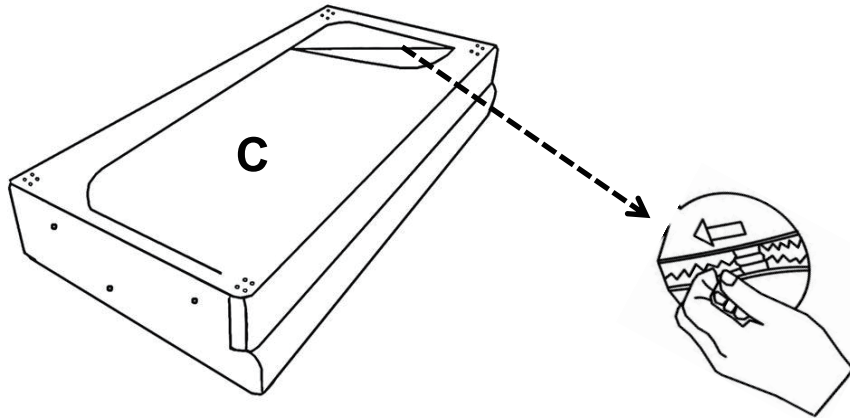

부품은 소파 하단 지퍼 안쪽에 포장되어 있습니다.

2

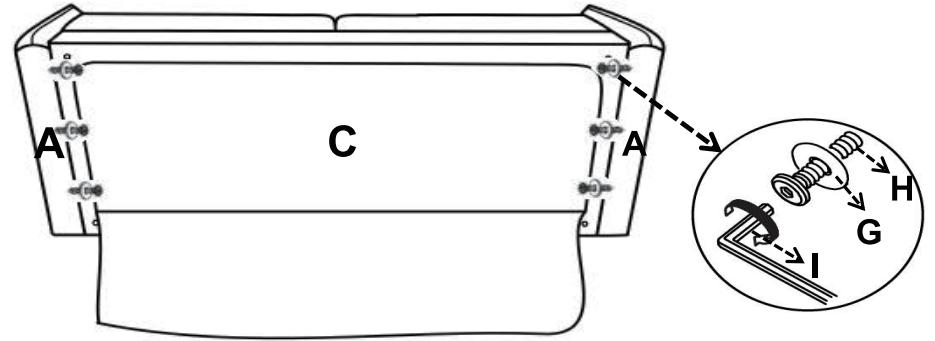

나사(H) 조립 전 와셔(G)를 체결한 후 조립해주세요.

※ 왼쪽, 오른쪽 나사구멍에 나사를 각각 고정 후 조여주세요.

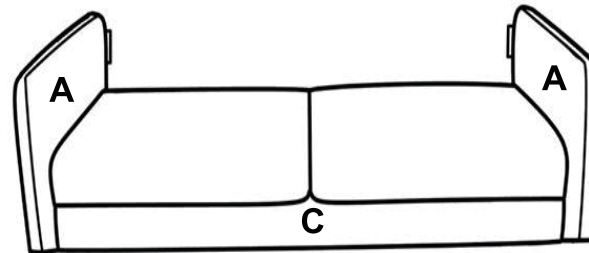

커버를 연체 팔걸이(A)와 본체(C)를 나사(H)를 이용하여 조립해 주세요.

3

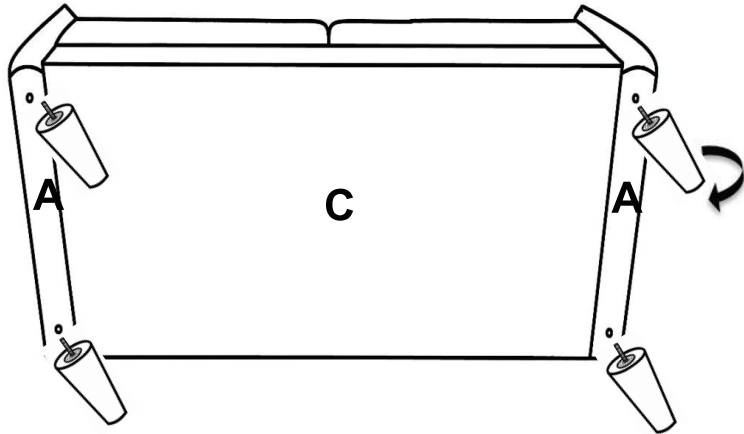

바닥패드(J)를 다리(F)에 부착 후 조립해주세요.

4

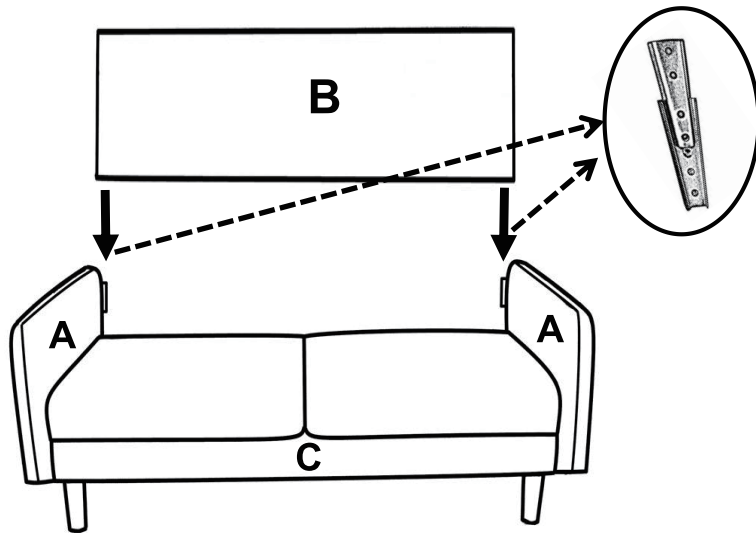

등받이(B)를 양쪽 브라켓에 맞추어 딸깍 소리가 날때까지 눌러 조립해주세요.

5

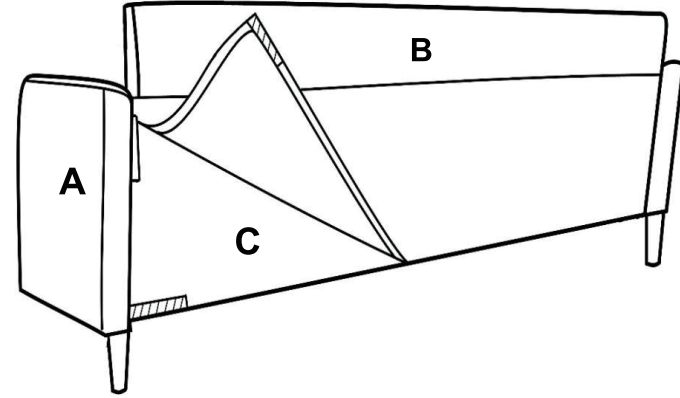

등받이(B)를 장착한 후 리어 커버를 아래로 당겨 벨크로를 본체(C)에 고정해주세요.

6

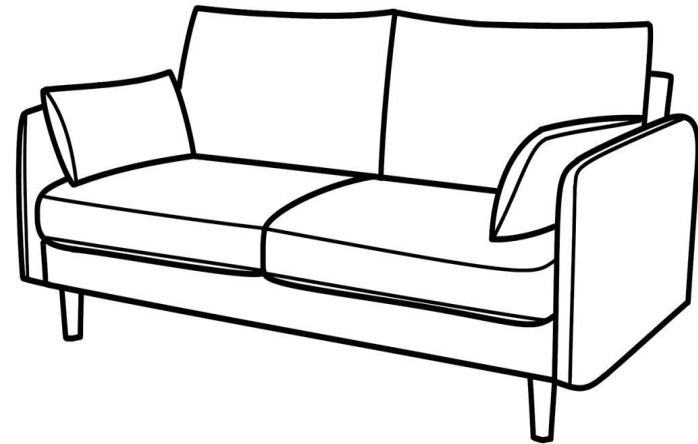

등받이 쿠션(D)와 쿠션(E)를 설치해주세요.